

**RoHS**

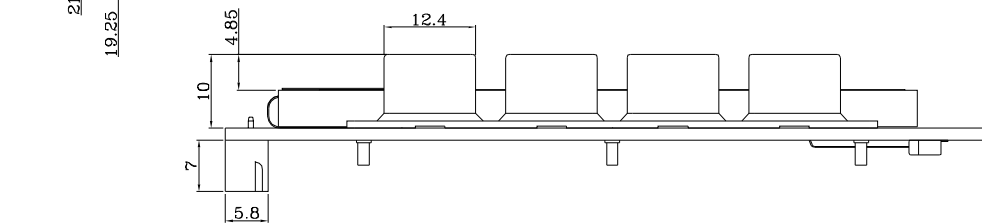

- NOTES:
1. DRIVE METHOD: 1/16DUTY, VDD 2.8V VCC 12V.
  2. DISPLAY COLOR: WHITE
  3. OPERATING TEMP: -20 TO 70°C.
  4. STORAGE TEMP: -30 TO 80°C.
  5. INTERFACE: RS232
  6. NOT DIMENSION TOLERANCES IS  $\pm 0.3$

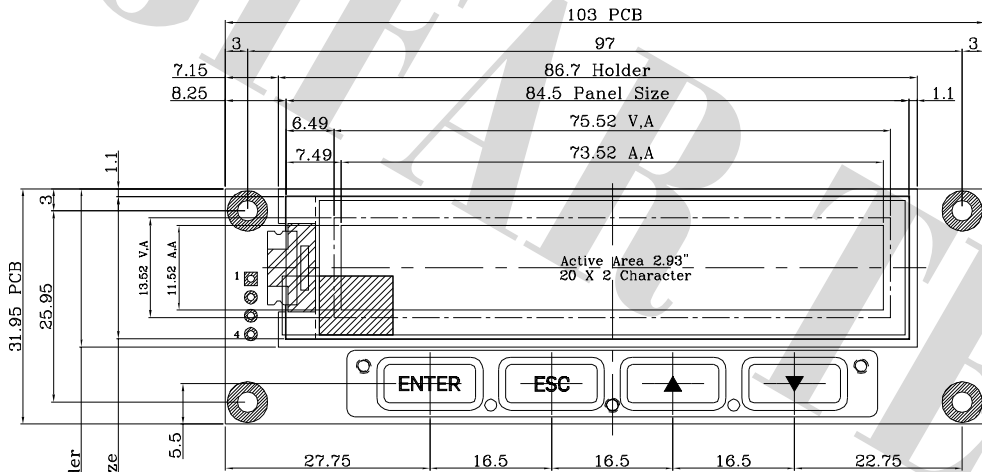
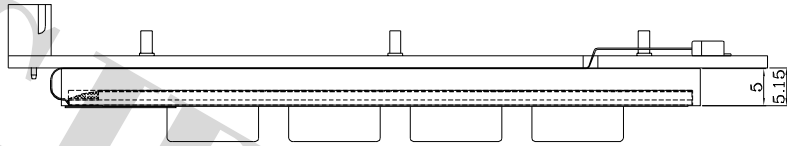
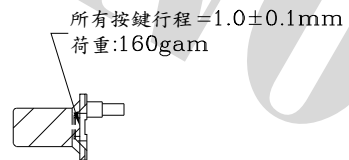
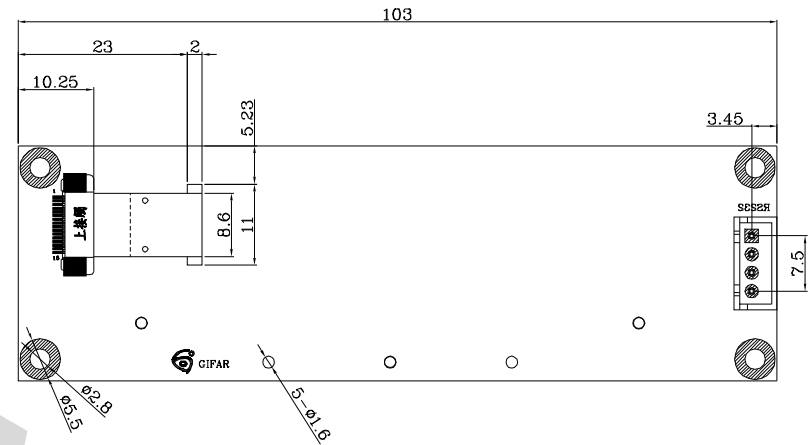
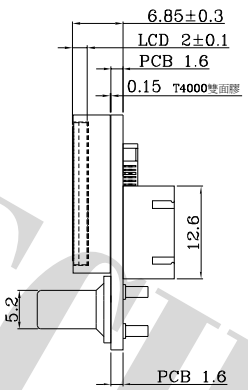

- KEY:
1. color of Rubber: White.
  2. color of text: pantone425.
  3. 噴保護漆 .

INTERFACE

PIN	NAME
1	VDD
2	GND
3	RXD
4	TXD

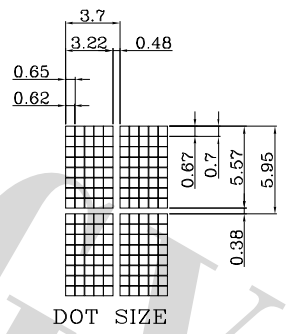

DOT SIZE

日期	版本	修改內容
170512	00	OLED+下方4KEY 灰 不印刷, 新料號為GFOR2002C-WG
170516	01	PCB長度縮小2mm。
170712	02	pcb key角柱定位孔預留5個。
170725	03	key修改要有印刷(KEY-IR1602B-05C)按鈕-白底/印刷字-Pantone425



**晶發科技股份有限公司**  
GOFAR TECHNOLOGY CO., LTD

<b>DATE</b>	2017.07.25	<b>REV</b>	03	<b>DRAWING NO.:</b>	R01-2017051101
<b>UNIT:</b>	mm	<b>Product:</b>	GFOR2002C-WG		
<b>SCALE:</b>	1/1	<b>DRAWN:</b>	Hazel	<b>CHECKED:</b>	Donlin
		<b>PAGE:</b>	1/1		