





# SPECIFICATIONS

**CUSTOMER** : \_\_\_\_\_  
**MODEL NO.** : **GFTRU043FA480272-JD7**  
**VERSION** : **0.2**  
**DATE** : **2017.10.06**  
**CERTIFICATION** : **ROHS**  
**CUSTOMER SIGN** : \_\_\_\_\_

QA Approved By	Approved By	Prepared By	Prepared By
			

晶發科技股份有限公司  
GI FAR TECHNOLOGY CO., LTD.

新北市樹林區東豐街 81 號

No. 81, Dongfeng St, Shulin District, 23874, New Taipei City, Taiwan, R.O.C.

TEL: +886-2-8684-1188 FAX: +886-2-8684-8532





## CONTENTS

1.Description	-----	4
2.Product Specifications	-----	4
3.Features	-----	5
3.1 Features	-----	5
3.2 Electrical Absolute Rating	-----	5
4.Pin Assignment	-----	8
4.1 RS232	-----	8
4.2 USB	-----	8
5.Mechanical Drawing	-----	9
5.1 LCM	-----	9
5.2 PCB	-----	10
6.RELIABILITY	-----	11
7.NOTES	-----	12
8.OPERATION PRECAUTIONS	-----	12
9.Inspection Standard	-----	13



## 1. Description

The specifications is a transmissive type color active matrix liquid crystal display (LCD) which uses amorphous thin film transistor (TFT) as switching devices. This product is composed of a TFT LCD panel, driver IC and a FPC unit. The following table described the features of JD7.

## 2. PRODUCT SPECIFICATIONS

Item	Standard Value	Unit
Resolution	480 x 3(RGB) x 272 Dots	
LCD Type	a-Si TFT, Normally White, Transmissive	
Screen Size(inch)	4.3	inch
Viewing Direction	6 O'clock	-
Color Configuration	RGB-Strip	-
Pixel Pitch	0.198(H) x 0.1998(V)	mm
Active Area	95.04(H) x 53.856(V)	mm
LCM Outline Dimension	102.04(H) x 63.006(V) x 1.43(D)	mm
PCB Outline Dimension	138.5(H) x 62.0(V) x 1.0(D)	mm
Black Light	LED	
Interface	USB, RS232	

Note 1: Refer to Mechanical Drawing.



### 3. Features

#### 3.1 Features

- Color Depth : 16M Colors
- Supporting Interface :
  - USB
  - RS232
- Available in standard ASCII characters, font sizes from 8x8 to 36x49.
- Provide instructions for points, lines, circles, rectangles.

#### 3.2 Electrical Absolute Rating

##### 3.2.1 Absolute Maximum Ratings

Characteristic	Symbol	Value	Unit
Operating Voltage (logic)	$V_{DD}$	-0.3 to +5.5	V
Logic Signal Input Level	$V_i$	0.3 to $V_{DD}+0.3$	V
Storage Temperature	$T_{ST}$	-30 to 80	°C
Operating Temperature	$T_{OP}$	-20 to 70	°C

Note 1: Referenced to  $V_{SS}=0V$

##### 3.2.2 Back-Light Unit

Item	Symbol	Min.	Typ.	Max.	Unit
Forward Voltage	$V_F$	21.1	23.1	25.2	V
Forward Current	$I_F$		20	25	mA

##### 3.2.3 Optical Specification

Item	Symbol	Condition	Min.	Typ.	Max.	Unit	
Response Time	Rise	$T_a = 25^\circ C$ $\theta x, \theta y = 0^\circ$	-	10	20	ms	Note2
	Fall		-	20	30		
Viewing Angle	Top	$CR \geq 10$	-	50	-	Deg.	Note4
	Bottom		-	55	-		
	Left		-	60	-		
	Right		-	60	-		
Contrast Rate		CR	200	250	-	-	Note3
Color of CIE Coordinate	White	X		0.31		-	NoteA
		Y		0.34			
Brightness		IV	$I_F = 20mA$	250	300	cd/m <sup>2</sup>	NoteA
Uniformity		$\Delta B$	$I_F = 20mA$	75		%	

Note A:



\*1:  $\Delta B = B(\min) / (\max)$

\*2: Measurement Condition for Optical Characteristics:

a: Environment  $25^{\circ}\text{C} \pm 5^{\circ}\text{C}$  /  $60 \pm 20\text{R.H}$ , no wind, dark room below 10 Lux at typical lamp current and typical operating frequency.

b: Measurement Distance  $500 \pm 50\text{mm}$  ( $\theta = 0^{\circ}$ )

c: Equipment: TOPCON BM-7 fast, (field  $1^{\circ}$ ), after 10 minutes operation.

d: The uncertainty of the C.I.E coordinate measurement  $\pm 0.01$ , Average Brightness  $\pm 4$

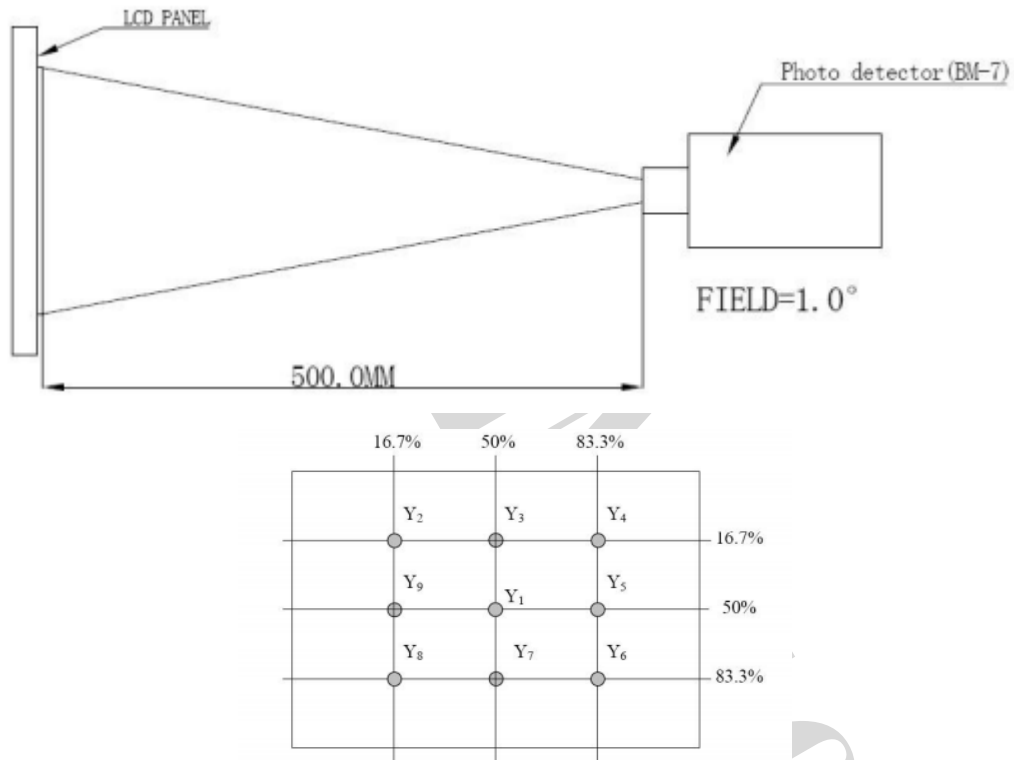

$$\text{Luminance Uniformity} = \frac{(\text{Min Luminance of 9 points})}{(\text{Max Luminance of 9 points})}$$

Note1: To be measured at the center area of panel with a viewing cone of  $1^{\circ}$  by Topcon luminance meter BM-7, after 10 minutes operation (module)

Note2: Definition of Response time:

The output signals of photo detector are measured when the input signals are changed from “black” to “white” (falling time) and from “white” to “black” (rising time), respectively. The response time is defined as the time interval between the 10% and 90% of Amplitudes.

Refer to figure as below:

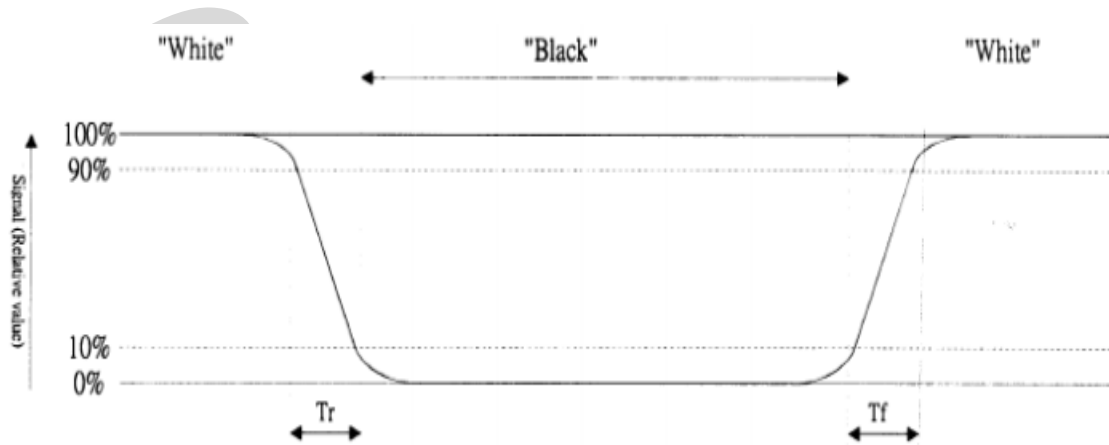

Note3: Definition of contrast ratio:

Contrast ratio is calculated with the following formula

$$\text{Contrast ratio (CR)} = \frac{\text{Photo detector output when LCD is at "White" state}}{\text{Photo detector output when LCD is at "Black" state}}$$

Note4: Definition of viewing angle:

Refer to figure as below:

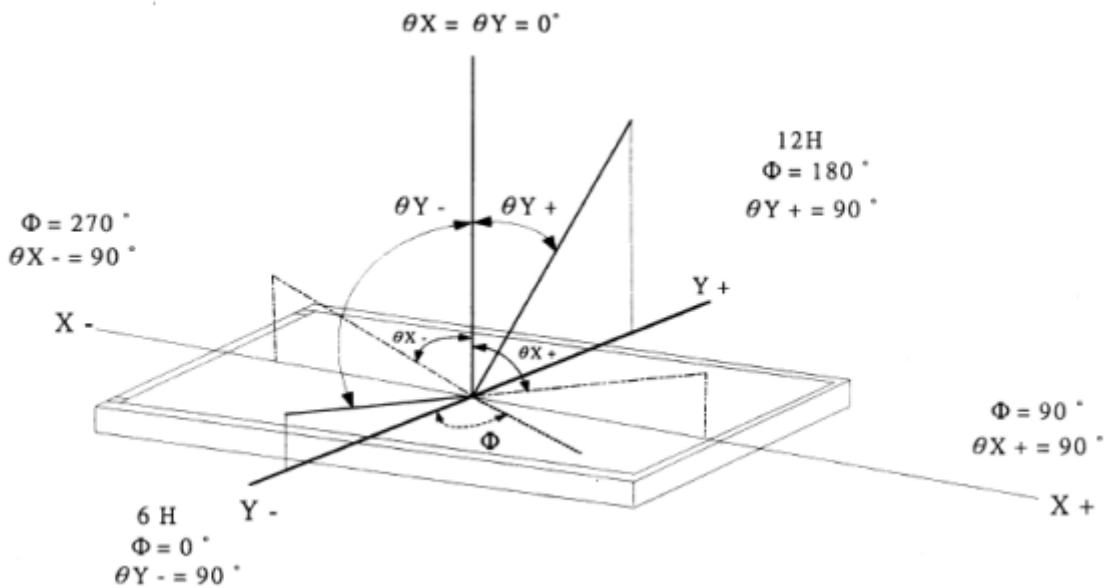



## 4. Pin Assignment

### 4.1 RS232 (CON 3)

Pin No.	Symbol	I/O	Function	Remark
1	V <sub>DD</sub>	P	DC 5V	
2	RX	O	Transmit Data	LCM to PC
3	TX	I	Receiver Data	PC to LCM
4	GND	P	Ground	

### 4.2 USB (CON 4)

Pin No.	Symbol	I/O	Function	Remark
1	V <sub>DD</sub>	P	DC 5V	
2	D-	I/O	USB Port D- Signal	
3	D+	I/O	USB Port D+ Signal	
4	NC	--	No Connection	
5	GND	P	Ground	





## 5. Mechanical Drawing

### 5.1 LCM

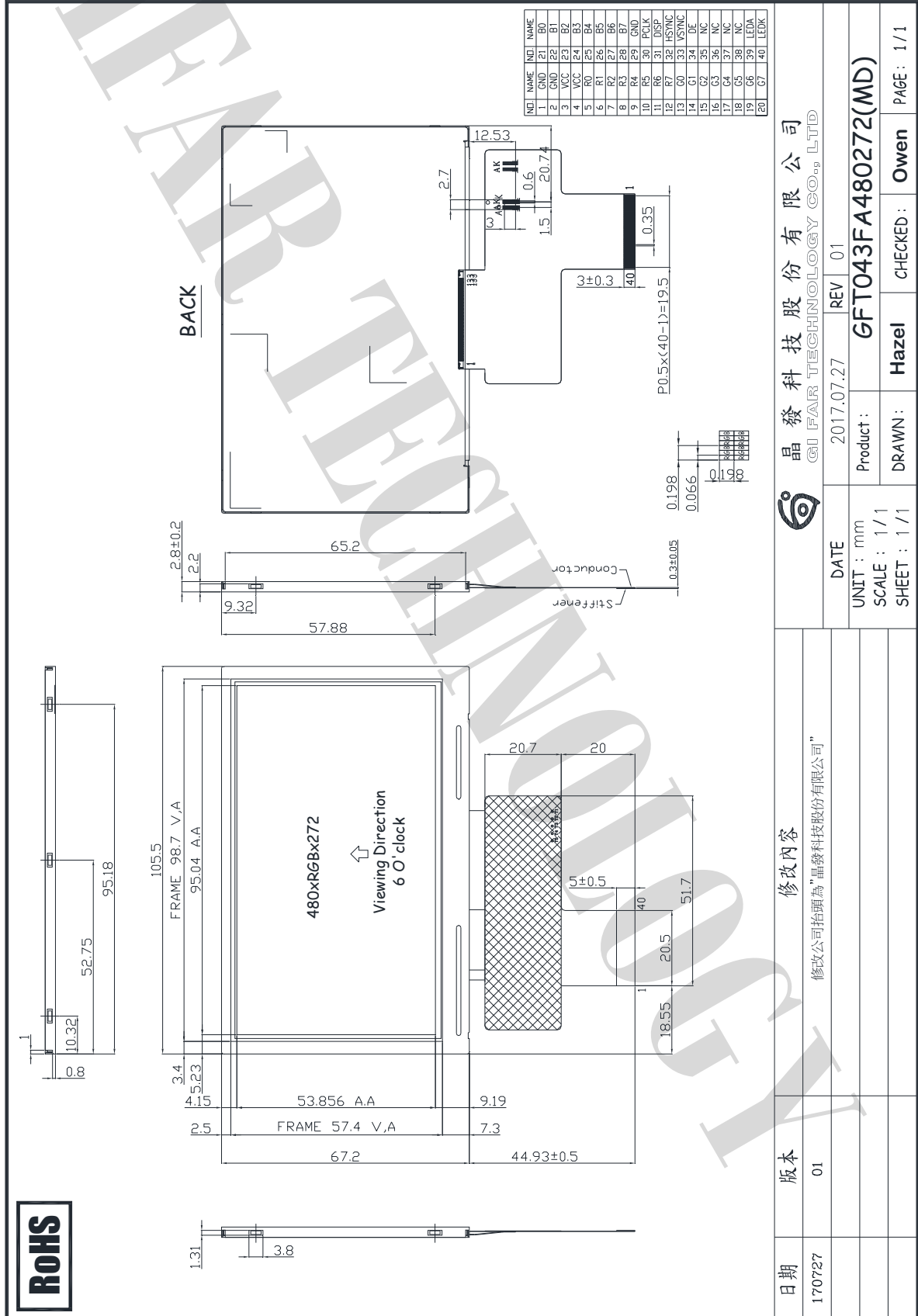



5.2 PCB

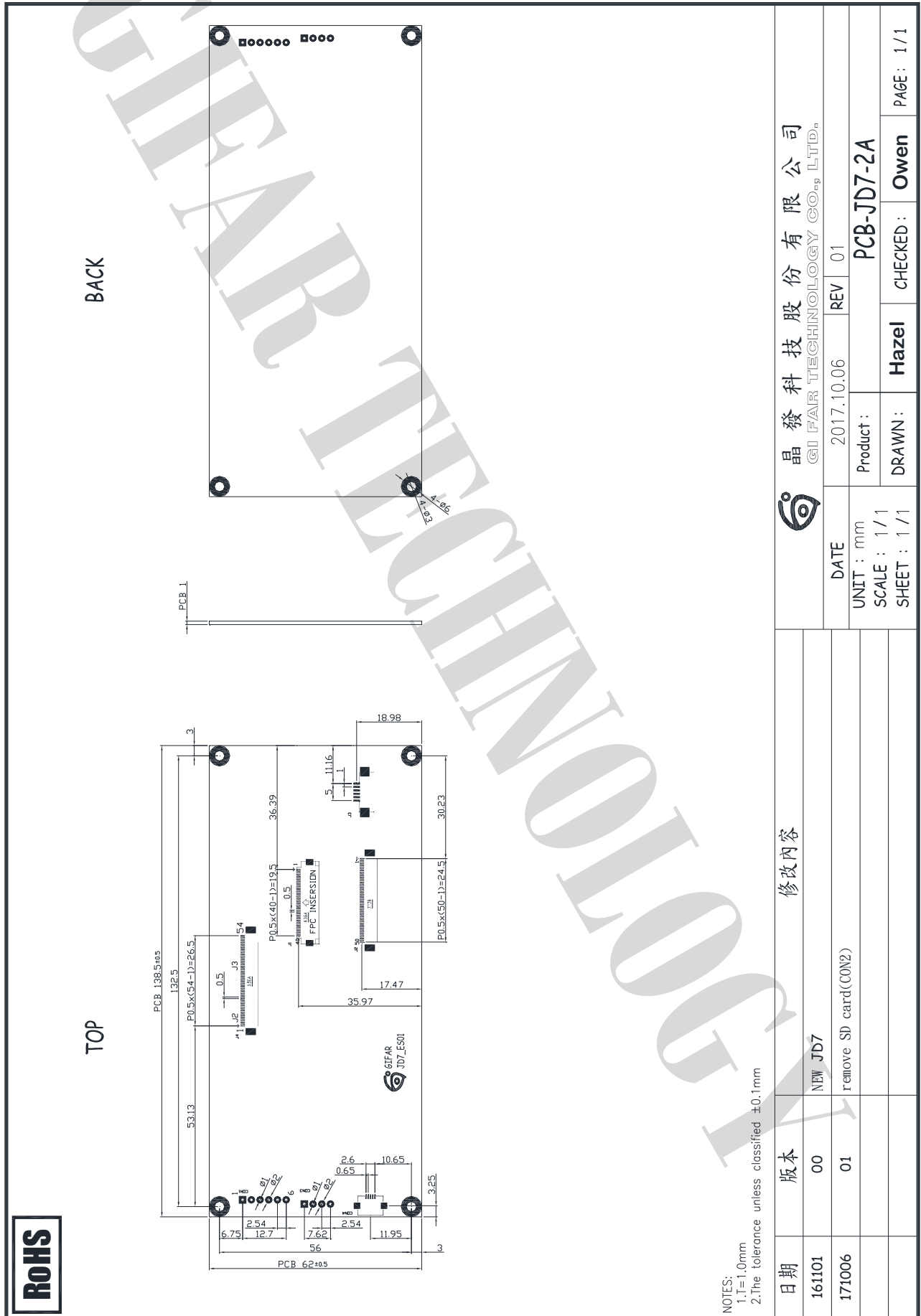



## 6. RELIABILITY

NO.	ITEM	CONDITION		STANDARD	NOTE
1	High Temp. Storage	80°C	120 hrs	Appearance Without defect	
2	Low Temp. Storage	-30°C	120 hrs	Appearance Without defect	
3	High Temp. & High Humi. Storage	60°C 90% RH	120 hrs	Appearance Without defect	
4	High Temp. Operating Display	70°C	120 hrs	Appearance Without defect	
5	Low Temp. Operating Display	-20°C	120 hrs	Appearance Without defect	
6	Thermal Shock	-30°C, 30min. → 80°C, 30min. ↑ (1cycle)		Appearance Without defect	10 cycles

Note 1: Ta is the ambient temperature of samples.

Note 2: Ts is the temperature of panel's surface.

Note 3: In the standard condition, there shall be no practical problem that may affect the display function. After the reliability test, the product only guarantees operation, but doesn't guarantee all the cosmetic specification.

Note 4: Before cosmetic and function tests, the product must have enough recovery time, at least 2 hours at room temperature.

Note 5: Before cosmetic and function tests, the product must have enough recovery time, at least 24 hours at room temperature.



## 7. NOTES

### ▪ Safety

- If the LCD panel breaks, be careful not to get the liquid crystal in your mouth. If the liquid crystal touches your skin or clothes, wash it off immediately using soap and plenty of water.

### Handling

- Avoid static electricity as this can damage the CMOS LSI.
- The LCD panel is plate glass; do not hit or crush it.
- Do not remove the panel or frame from the module.
- The polarizing plate of the display is very fragile; handle it very carefully

### Mounting and Design

- Mount the module by using the specified mounting part and holes.
- To protect the module from external pressure, leave a small gap by placing transparent plates (e.g. acrylic or glass) on the display surface, frame, and polarizing plate
- Design the system so that no input signal is given unless the power-supply voltage is applied.
- Keep the module dry. Avoid condensation, otherwise the transparent electrodes may break.

### Storage

- Store the module in a dark place where the temperature is  $25^{\circ}\text{C} \pm 10^{\circ}\text{C}$  and the humidity below 65% RH.
- Do not store the module near organic solvents or corrosive gases.
- Do not crush, shake, or jolt the module (including accessories).

### Cleaning

- Do not wipe the polarizing plate with a dry cloth, as it may scratch the surface.
- Wipe the module gently with soft cloth soaked with a petroleum benzine.
- Do not use ketonic solvents (ketone and acetone) or aromatic solvents (toluene and xylene), as they may damage the polarizing plate.

## 8. OPERATION PRECAUTIONS

Any changes that need to be made in this specification or any problems arising from it will be dealt with quickly by discussion between both companies.

Quality warranty period: Within one year after shipment date (excluding abnormal usage way and abnormal environments.)

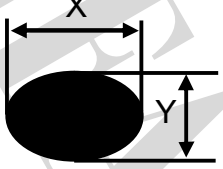
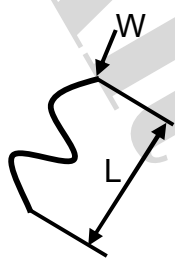

## 9. Inspection Standard

No	Item	Criteria	Rank	Remark												
1	Spots	$\varphi = (X + Y)/2$  <table border="1"> <thead> <tr> <th><math>\varphi</math> (mm)</th> <th>Acceptable Qty</th> </tr> </thead> <tbody> <tr> <td><math>\varphi \leq 0.25</math></td> <td>Ignore</td> </tr> <tr> <td><math>0.25 &lt; \varphi \leq 0.5</math></td> <td>3</td> </tr> <tr> <td><math>\varphi &gt; 0.5</math></td> <td>0</td> </tr> </tbody> </table> Defect distance > 5mm	$\varphi$ (mm)	Acceptable Qty	$\varphi \leq 0.25$	Ignore	$0.25 < \varphi \leq 0.5$	3	$\varphi > 0.5$	0		Minor AQL0.65%				
$\varphi$ (mm)	Acceptable Qty															
$\varphi \leq 0.25$	Ignore															
$0.25 < \varphi \leq 0.5$	3															
$\varphi > 0.5$	0															
2	Lines	 <table border="1"> <thead> <tr> <th>L(mm)</th> <th>W(mm)</th> <th>Acceptable Qty</th> </tr> </thead> <tbody> <tr> <td>--</td> <td><math>W \leq 0.01</math></td> <td>Ignore</td> </tr> <tr> <td><math>L \leq 3.0</math></td> <td><math>0.01 &lt; W \leq 0.05</math></td> <td>3</td> </tr> <tr> <td><math>L &gt; 3.0</math></td> <td><math>W &gt; 0.05</math></td> <td>0</td> </tr> </tbody> </table>	L(mm)	W(mm)	Acceptable Qty	--	$W \leq 0.01$	Ignore	$L \leq 3.0$	$0.01 < W \leq 0.05$	3	$L > 3.0$	$W > 0.05$	0		Minor AQL0.65%
L(mm)	W(mm)	Acceptable Qty														
--	$W \leq 0.01$	Ignore														
$L \leq 3.0$	$0.01 < W \leq 0.05$	3														
$L > 3.0$	$W > 0.05$	0														
3	Bright/Dark Dot	<table border="1"> <thead> <tr> <th></th> <th>Acceptable Qty</th> </tr> </thead> <tbody> <tr> <td>Bright Dot</td> <td><math>N \leq 2</math></td> </tr> <tr> <td>Dark Dot</td> <td><math>N \leq 3</math></td> </tr> </tbody> </table> Dot defect > 1/2 Dot Bright Dot : Use 2% ND filter not visible in black pattern. Dark Dot : Test pattern red 、 green 、 blue		Acceptable Qty	Bright Dot	$N \leq 2$	Dark Dot	$N \leq 3$		Minor AQL0.65%						
	Acceptable Qty															
Bright Dot	$N \leq 2$															
Dark Dot	$N \leq 3$															
4	No Display	No Signal Outputs In Display		Major AQL0.4%												
5	Line Defect	Not Allowed Any Vertical / Horizontal / Cross Line		Major AQL0.4%												
6	Mura	All kinds of Mura should be judged by equivalent limit sample		Minor AQL0.65%												
7	Irregular Display	Not Allowed Abnormal Signal Outputs In Display		Major AQL0.4%												
8	Outline size	Out of spec. is not permitted		Major AQL0.4%												